

December 14 - Daily Quiz 1

Solve for x.

1.

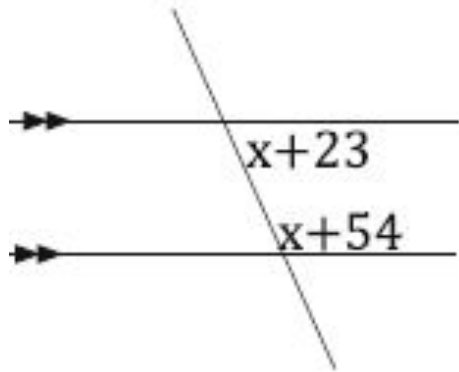

2.

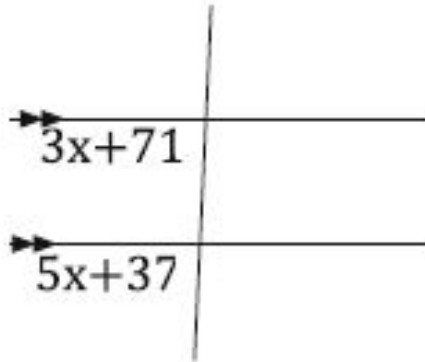

3.

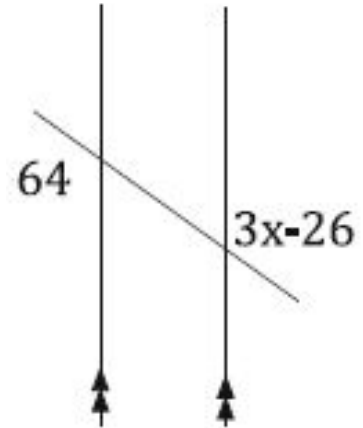

December 17 - Daily Quiz 2

Find the surface area.

1.

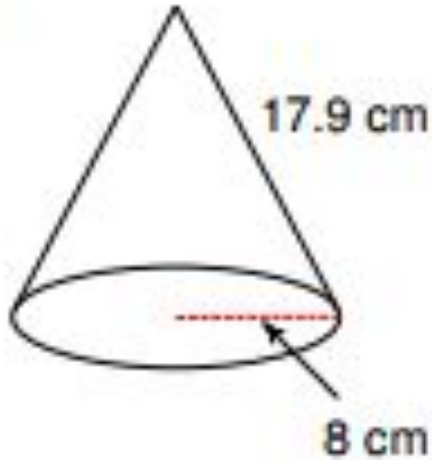

2.

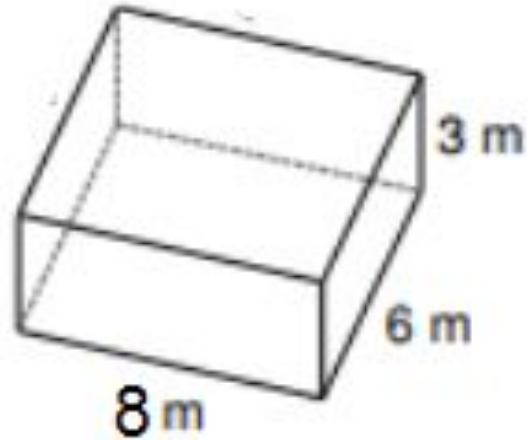

December 18 - Daily Quiz 3

Determine the volume of:

1.

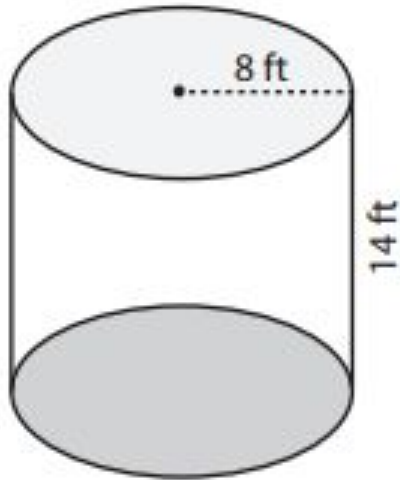

2.

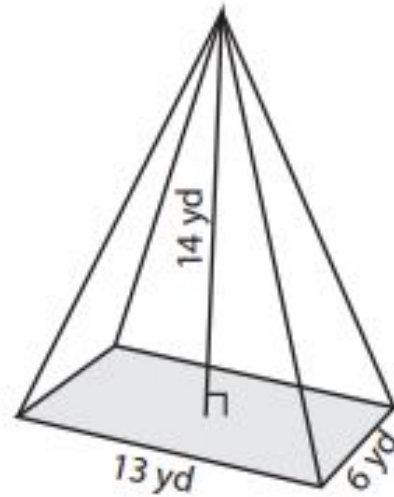

December 20 - Daily Quiz 4

Draw a picture of a t-rex pretending to be Santa.

December 21 - Daily Quiz 5

I teach FOM 3 every year in the fall.

What advice would you give my students next year on how to survive and succeed in this class?

(Keep it appropriate.)